

## CTH3-A



### ROOF FAN, AL COWL 400°C/2h

#### MANUFACTURING FEATURES

- Roof cowl made of aluminium
- Structure, roof base support and bird protection guard made of galvanised steel.
- High efficiency backward impeller with self-cleaning system of steel.
- Standard asynchronous motor with IP-55 protection and Class F insulation. Manufactured with standard voltages: 230V 50Hz in single phase motors, 230/400V 50Hz in three phase motors and 400V 50Hz in 2 speed motors

#### APPLICATIONS

Specially designed for roof installation, they are suitable for:

- Smoke extraction.
- Smoke emergency exhaust with motor outside the hazardous area.
- Air renewal in buildings and industries.
- Industrial and professional kitchen hoods.
- Maximum continuous working temperature: carried air 110°C, environment 60°C for three phase and 50°C for single phase motors.

## Accessories



BTI

CMP

INT

INT  
400

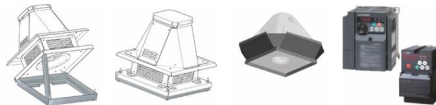

KB

KF

KV  
CTH3

SFC

#### UNDER REQUEST

- 60Hz and special voltages.
- Sparking proof fan with EEx\_d certified motor.

Official homologation by the European laboratory APPLUS according to EN 12101-3:2015  
Certification Nr: 0370-CPR-2656

## Technical data

### Single-phase motor / 4 poles

Code	Model	R.P.M.	Rated I. (A) 230V	Rated power kW	Max. Airflow w m3/h	Sound db (A)**	Weight	Connect. diagram
279220103A	CTH3-A 225 M4 0,12kW	1380	1,15	0,12	730	36	9	1
279250103A	CTH3-A 250 M4 0,12kW	1380	1,15	0,12	880	39	10	1
279280103A	CTH3-A 280 M4 0,12kW	1380	1,15	0,12	1.520	44	11	1
279310103A	CTH3-A 315 M4 0,25KW	1400	1,93	0,25	2.190	43	15	1

### Single-phase motor / 6 poles

Code	Model	R.P.M.	Rated I. (A) 230V	Rated power kW	Max. Airflow w m3/h	Sound db (A)**	Weight	Connect. diagram
279410103A	CTH3-A 400 M6 0,37KW	890	2,9	0,37	3.320	41	21	1

### Three-phase motor / 4 poles

Code	Model	R.P.M.	Rated I. (A) 400V	Rated power kW	Max. Airflow w m3/h	Sound db (A)**	Weight	Connect. diagram
279220106A	CTH3-A 225 T4 0,12kW	1400	0,46	0,12	730	36	9	2
279250106A	CTH3-A 250 T4 0,12kW	1400	0,46	0,12	880	39	10	2
279280106A	CTH3-A 280 T4 0,12kW	1400	0,46	0,12	1.520	44	11	2
279310106A	CTH3-A 315 T4 0,25KW	1400	0,79	0,25	2.190	43	15	2
279350106A	CTH3-A 355 T4 0,55KW	1400	1,49	0,55	3.590	48	19	2
279400106A	CTH3-A 400 T4 0,75KW	1390	1,63	0,75	5.130	51	21	2
279450106A	CTH3-A 450 T4 1,1KW	1400	2,49	1,1	7.300	54	38	2
279500106A	CTH3-A 500 T4 1,5KW	1400	3,26	1,5	10.010	57	50	2
279560106A	CTH3-A 560 T4 3KW	1430	6,17	3	14.060	61	55	2

### Three-phase motor / 6 poles

Code	Model	R.P.M.	Rated I. (A) 400V	Rated power kW	Max. Airflow w m3/h	Sound db (A)**	Weight	Connect. diagram
279410106A	CTH3-A 400 T6 0,37KW	900	1,27	0,37	3.320	41	21	2
279460106A	CTH3-A 450 T6 0,37KW	910	1,27	0,37	4.730	45	38	2

Code	Model	R.P.M.	Rated I. (A) 400V	Rated power kW	Max. Airflow w m3/h	Sound db (A)**	Weight t	Connect. diagram
279510106A	CTH3-A 500 T6 0,75KW	910	1,95	0,75	6.490	48	50	2
279570106A	CTH3-A 560 T6 0,75KW	910	1,95	0,75	9.110	51	55	2
279630106A	CTH3-A 630 T6 1,5KW	940	3,71	1,5	13.230	55	70	2
279710106A	CTH3-A 710 T6 2,2KW	940	5,94	2,2	18.940	59	170	2
279800106A	CTH3-A 800 T6 4KW	960	9,46	4	27.090	62	205	2
279900106A	CTH3-A 900 T6 11KW	965	22,6	11	37.660	67	250	2

### Three-phase motor / 8 poles

Code	Model	R.P.M.	Rated I. (A) 400V	Rated power kW	Max. Airflow w m3/h	Sound db (A)**	Weight t	Connect. diagram
279100106A	CTH3-A 1000 T8 7,5KW	-	17	7,5	39.590	65	411	2

### 2 SPEED MOTOR / 4/8 poles

Code	Model	R.P.M.	Rated I. (A) 400V	Rated power kW	Max. Airflow w m3/h	Sound db (A)**	Weight t	Connect. diagram
279310106A2V	CTH3-A 315 T4/T8 0,25/0,03KW	1370	1,13/0,37	0,25/0,03	2.190	43	15	3
279350106A2V	CTH3-A 355 T4/T8 0,55/0,09KW	1410	1,77/0,61	0,55/0,09	3.590	48	19	3
279400106A2V	CTH3-A 400 T4/T8 0,75/0,12KW	1400	2,03/0,68	0,75/0,12	5.130	51	21	3
279450106A2V	CTH3-A 450 T4/T8 1,1/0,18KW	1400	2,67/1,08	1,1/0,18	7.300	54	38	3
279500106A2V	CTH3-A 500 T4/T8 1,5/0,25KW	1400	3,46/1,27	1,5/0,25	10.010	57	50	3
279560106A2V	CTH3-A 560 T4/T8 3/0,55KW	1430	6,53/2,33	3/0,55	14.060	61	55	3

### 2 SPEED MOTOR / 6/12 poles

Code	Model	R.P.M.	Rated I. (A) 400V	Rated power kW	Max. Airflow w m3/h	Sound db (A)**	Weight t	Connect. diagram
279510106A2V	CTH3-A 500 T6/T12 0,75/0,15KW	910	2,11/0,59	0,75/0,15	6.490	48	50	3
279570106A2V	CTH3-A 560 T6/T12 0,75/0,15KW	910	2,11/0,59	0,75/0,15	9.110	51	55	3
279630106A2V	CTH3-A 630 T6/T12 1,5/0,25KW	940	14,97/3,97	1,5/0,25	10.210	55	70	3

Code	Model	R.P.M.	Rated I. (A) 400V	Rated power kW	Max. Airflow m <sup>3</sup> /h	Sound db (A)**	Weight	Connect. diagram
279710106A2V	CTH3-A 710 T6/T12 2,2/0,55KW	930	5,98/1,65	2,2/0,55	18.940	59	170	3
279800106A2V	CTH3-A 800 T6/T12 4/1KW	960	11,77/3,39	4/1	27.090	62	205	3

**Notes:**

\*\* Total sound pressure level at the point of maximum flow measured in dB(A) in the suction measured in free field at a distance of 6m from the source

## Dimensions

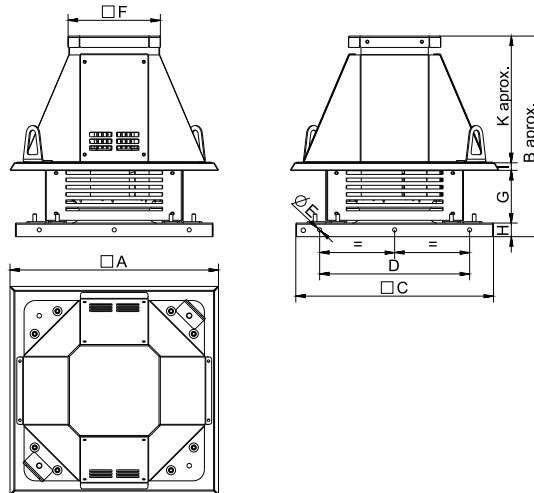

Model	A	B aprox	C	D	E	F	G	H	I
CTH3-A 225 M4 0,12kW	463	441,9	435	330	9	203	112,25	30	20,75
CTH3-A 225 T4 0,12kW	463	441,9	435	330	9	203	112,25	30	20,75
CTH3-A 250 M4 0,12kW	463	441,9	435	330	9	203	112,25	30	20,75
CTH3-A 250 T4 0,12kW	463	441,9	435	330	9	203	112,25	30	20,75
CTH3-A 280 M4 0,12kW	583	500	595	450	9	203	140,75	40	20,75
CTH3-A 280 T4 0,12kW	583	500	595	450	9	203	140,75	40	20,75
CTH3-A 315 M4 0,25KW	583	544,6	595	450	9	203	185,25	40	20,75
CTH3-A 315 T4 0,25KW	583	544,6	595	450	9	203	185,25	40	20,75
CTH3-A 315 T4/T8 0,25/0,03KW	583	544,6	595	450	9	203	185,25	40	20,75
CTH3-A 355 T4 0,55KW	664,6	644,6	665	520	9	253	210,8	40	30,75
CTH3-A 355 T4/T8 0,55/0,09KW	664,6	644,6	665	520	9	253	210,8	40	30,75
CTH3-A 400 M6 0,37KW	664,4	702,75	665	520	9	253	268,75	40	30,75
CTH3-A 400 T4 0,75KW	664,4	702,75	665	520	9	253	268,75	40	30,75
CTH3-A 400 T6 0,37KW	664,4	702,75	665	520	9	253	268,75	40	30,75
CTH3-A 400 T4/T8 0,75/0,12KW	664,4	702,75	665	520	9	253	268,75	40	30,75
CTH3-A 450 T4 1,1KW	774,6	758,15	665	520	9	253	304,25	40	30,75
CTH3-A 450 T6 0,37KW	774,6	758,15	665	520	9	253	304,25	40	30,75
CTH3-A 450 T4/T8 1,1/0,18KW	774,6	758,15	665	520	9	253	304,25	40	30,75
CTH3-A 500 T4 1,5KW	939,6	863,65	939	710	9	353	319,5	50	31
CTH3-A 500 T6 0,75KW	939,6	863,65	939	710	9	353	319,5	50	31
CTH3-A 500 T4/T8 1,5/0,25KW	939,6	863,65	939	710	9	353	319,5	50	31
CTH3-A 500 T6/T12 0,75/0,15KW	939,6	863,65	939	710	9	353	319,5	50	31
CTH3-A 560 T4 3KW	939,6	880,65	939	710	9	353	336,5	50	31
CTH3-A 560 T6 0,75KW	939,6	880,65	939	710	9	353	336,5	50	31
CTH3-A 560 T4/T8 3/0,55KW	939,6	880,65	939	710	9	353	336,5	50	31

Model	A	B aprox	C	D	E	F	G	H	I
CTH3-A 560 T6/T12 0,75/0,15KW	939,6	880,65	939	710	9	353	336,5	50	31
CTH3-A 630 T6 1,5KW	939,6	922,65	939	710	9	353	378,5	50	31
CTH3-A 630 T6/T12 1,5/0,25KW	939,6	922,65	939	710	9	353	378,5	50	31
CTH3-A 710 T6 2,2KW	1134,6	1116,22	1035	840	9	453	441,5	50	31
CTH3-A 710 T6/T12 2,2/0,55KW	1134,6	1116,22	1035	840	9	453	441,5	50	31
CTH3-A 800 T6 4KW	1134,6	1142,72	1035	840	9	453	468	50	31
CTH3-A 800 T6/T12 4/1KW	1134,6	1142,72	1035	840	9	453	468	50	31

Model	K aprox
CTH3-A 225 M4 0,12kW	278,9
CTH3-A 225 T4 0,12kW	278,9
CTH3-A 250 M4 0,12kW	278,9
CTH3-A 250 T4 0,12kW	278,9
CTH3-A 280 M4 0,12kW	298,5
CTH3-A 280 T4 0,12kW	298,5
CTH3-A 315 M4 0,25KW	298,5
CTH3-A 315 T4 0,25KW	298,5
CTH3-A 315 T4/T8 0,25/0,03KW	298,5
CTH3-A 355 T4 0,55KW	363,25
CTH3-A 355 T4/T8 0,55/0,09KW	363,25
CTH3-A 400 M6 0,37KW	363,25
CTH3-A 400 T4 0,75KW	363,25
CTH3-A 400 T6 0,37KW	363,25
CTH3-A 400 T4/T8 0,75/0,12KW	363,25
CTH3-A 450 T4 1,1KW	383,15
CTH3-A 450 T6 0,37KW	383,15
CTH3-A 450 T4/T8 1,1/0,18KW	383,15
CTH3-A 500 T4 1,5KW	463,15
CTH3-A 500 T6 0,75KW	463,15
CTH3-A 500 T4/T8 1,5/0,25KW	463,15
CTH3-A 500 T6/T12 0,75/0,15KW	463,15
CTH3-A 560 T4 3KW	463,15
CTH3-A 560 T6 0,75KW	463,15
CTH3-A 560 T4/T8 3/0,55KW	463,15
CTH3-A 560 T6/T12 0,75/0,15KW	463,15
CTH3-A 630 T6 1,5KW	463,15
CTH3-A 630 T6/T12 1,5/0,25KW	463,15
CTH3-A 710 T6 2,2KW	593,72
CTH3-A 710 T6/T12 2,2/0,55KW	593,72
CTH3-A 800 T6 4KW	593,72

Model	K aprox
CTH3-A 800 T6/T12 4/1KW	593,72

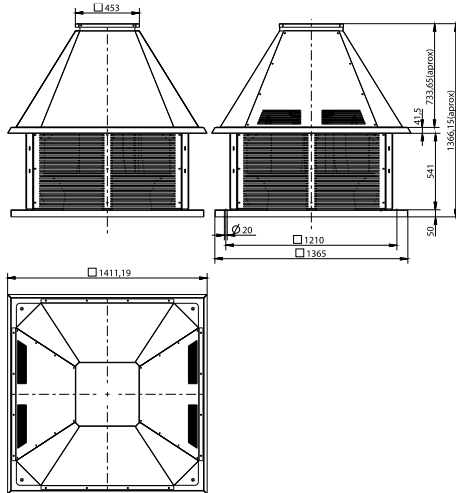

Model	CTH3-A 900
CTH3-A 900 T6 11KW	-

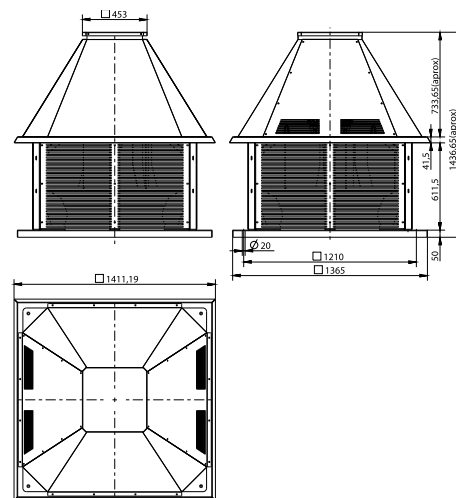

Model	CTH3-A 1000
CTH3-A 1000 T8 7,5KW	-

## Wiring diagram

DIAGRAM Nº 1

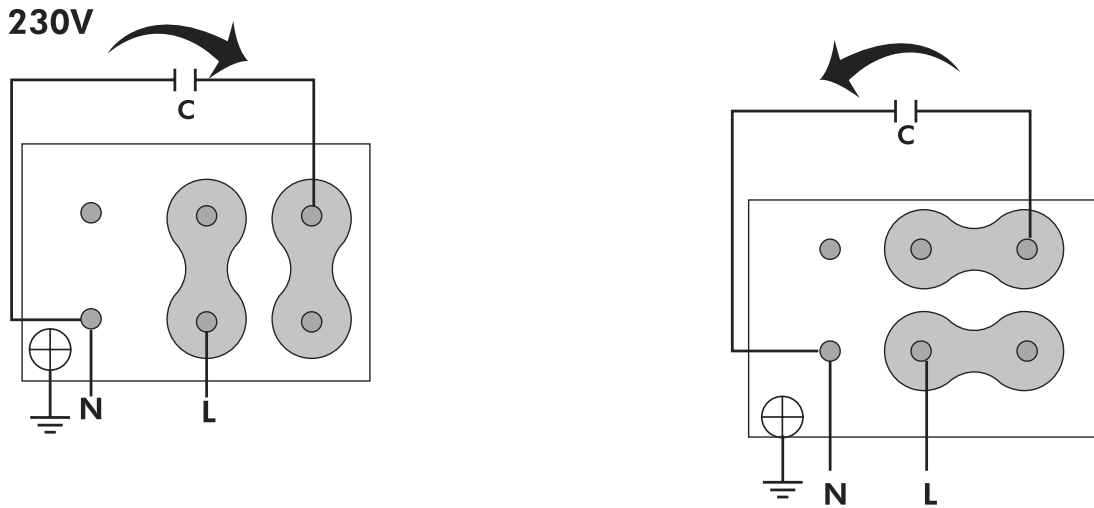

DIAGRAM Nº 2

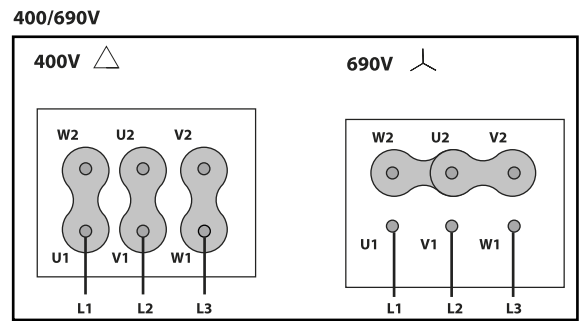
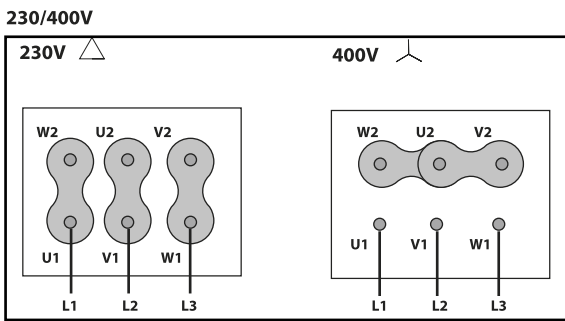
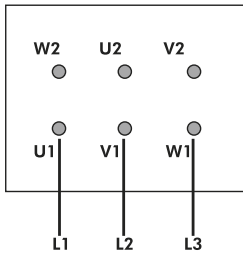

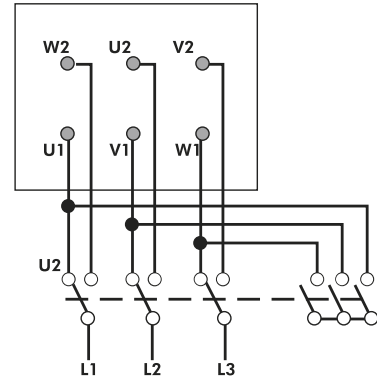
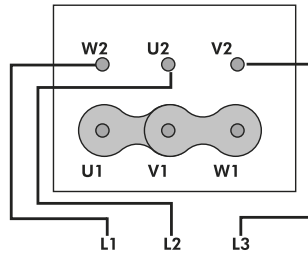

DIAGRAM N° 3

LOW SPEED  
VELOCIDAD BAJA



HIGH SPEED  
VELOCIDAD ALTA



# CHARACTERISTIC CURVE

1 CTH3-A 225 M4 0,12kW

2 CTH3-A 250 M4 0,12kW

3 CTH3-A 280 M4 0,12kW

4 CTH3-A 315 M4 0,25KW

## AIR FLOW - PRESSURE

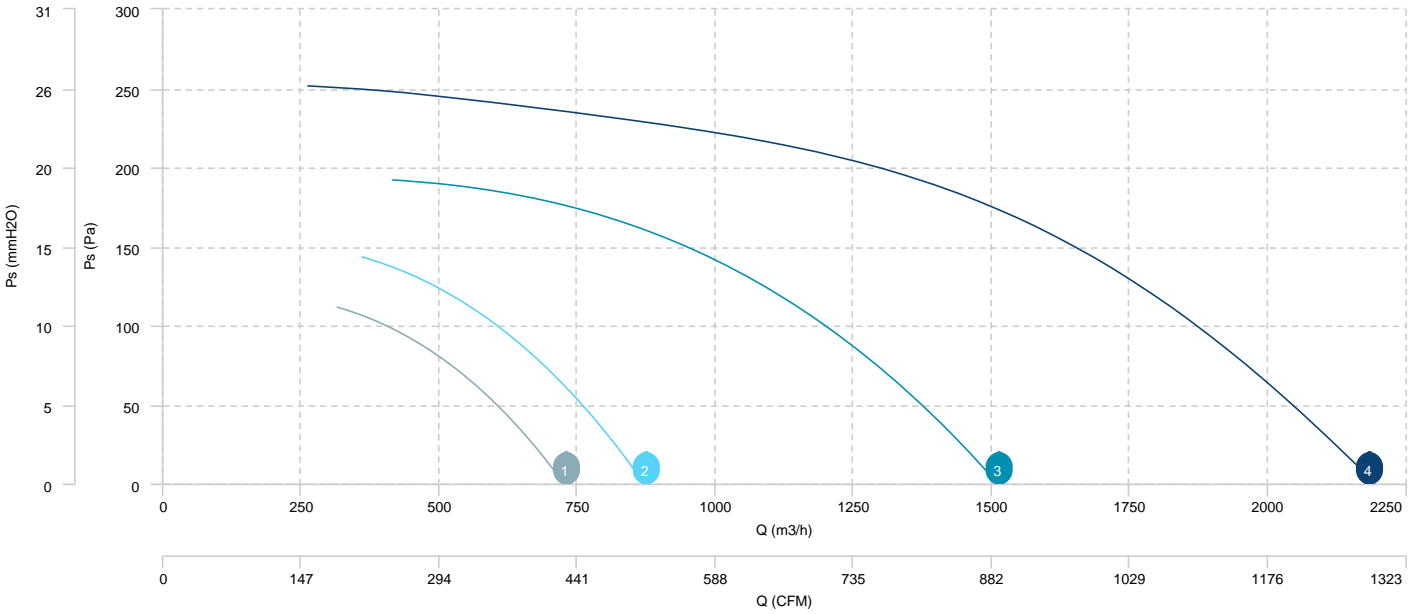

## AIR FLOW - ABSORBED POWER

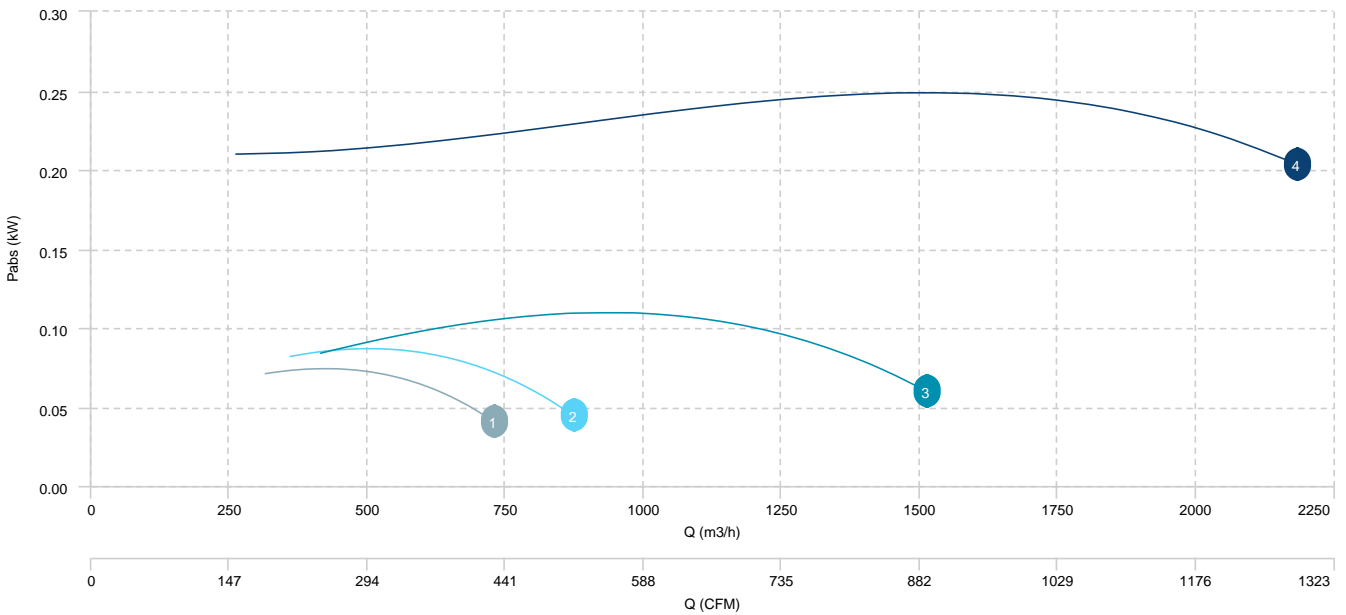

1 CTH3-A 400 M6 0,37KW

AIR FLOW - PRESSURE

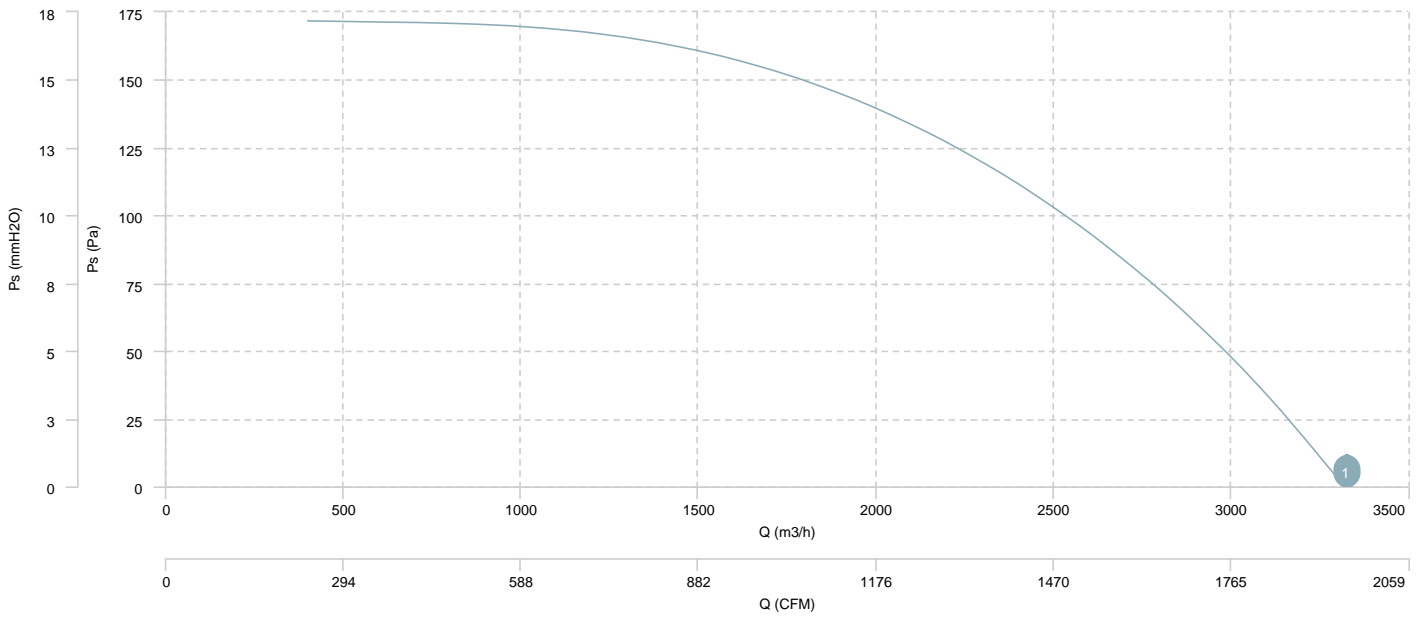

1	CTH3-A 225 T4 0,12kW	2	CTH3-A 250 T4 0,12kW	3	CTH3-A 280 T4 0,12kW	4	CTH3-A 315 T4 0,25KW
5	CTH3-A 355 T4 0,55KW	6	CTH3-A 400 T4 0,75KW	7	CTH3-A 450 T4 1,1KW	8	CTH3-A 500 T4 1,5KW
9	CTH3-A 560 T4 3KW						

## AIR FLOW - PRESSURE

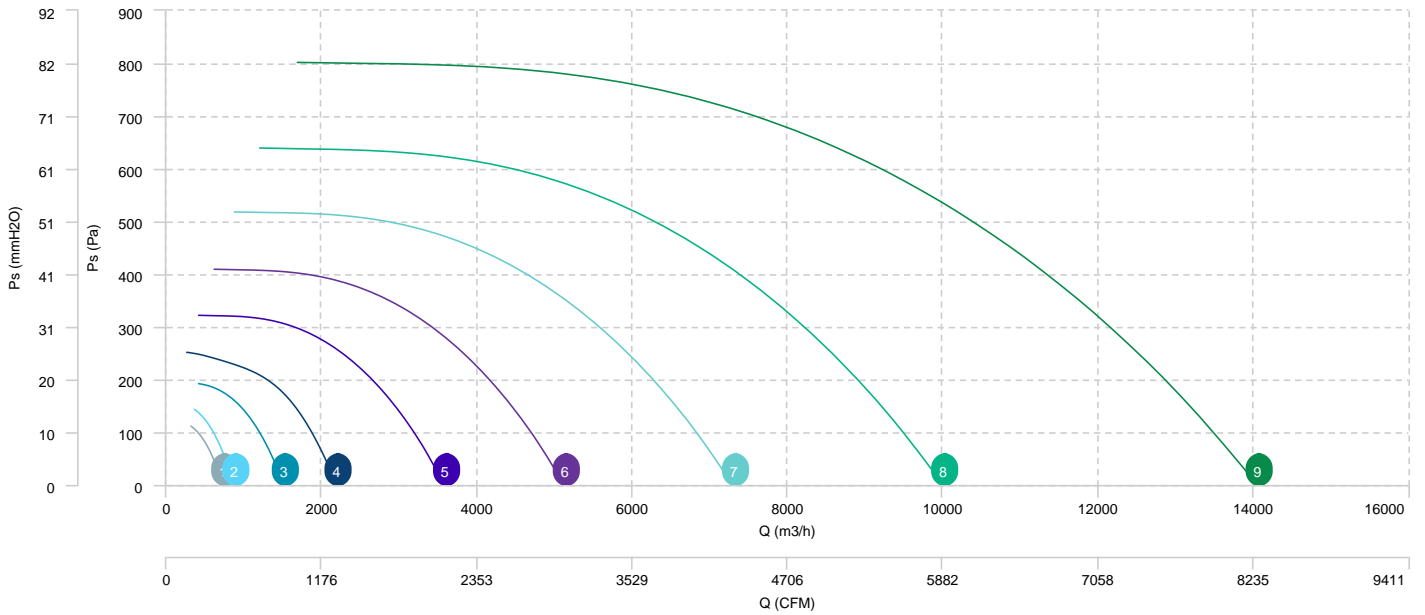

## AIR FLOW - ABSORBED POWER

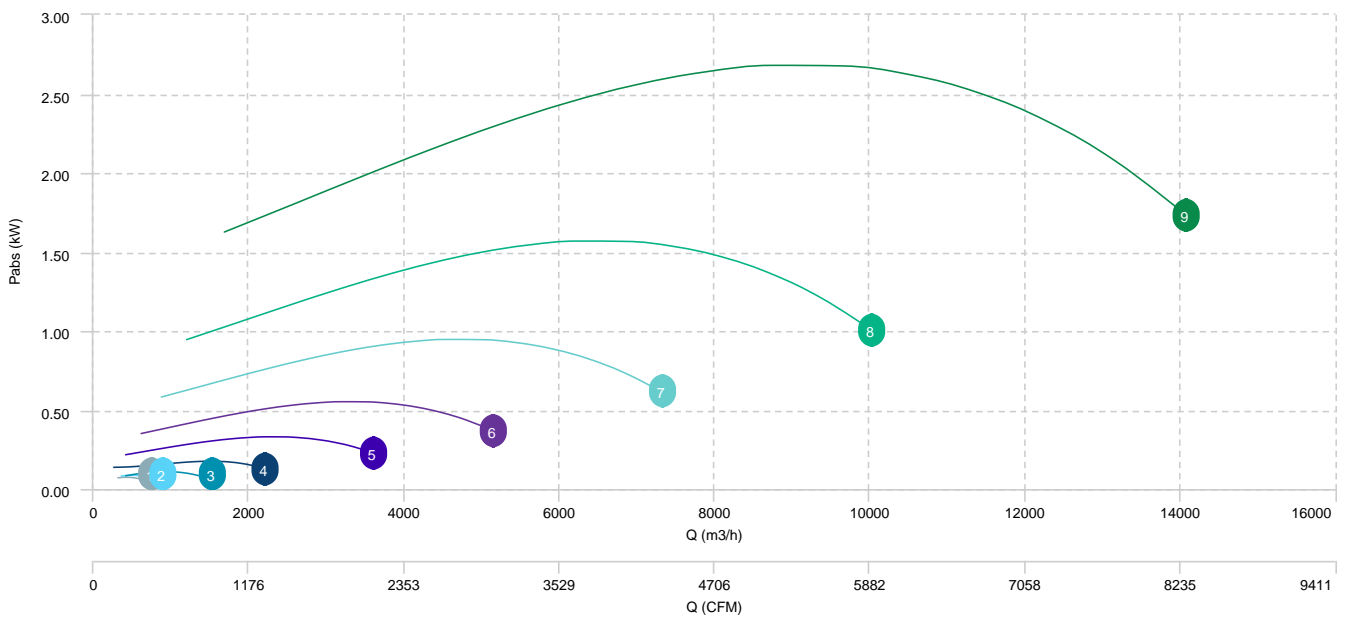

1	CTH3-A 400 T6 0,37KW	2	CTH3-A 450 T6 0,37KW	3	CTH3-A 500 T6 0,75KW	4	CTH3-A 560 T6 0,75KW
5	CTH3-A 630 T6 1,5KW	6	CTH3-A 710 T6 2,2KW	7	CTH3-A 800 T6 4KW	8	CTH3-A 900 T6 11KW

## AIR FLOW - PRESSURE

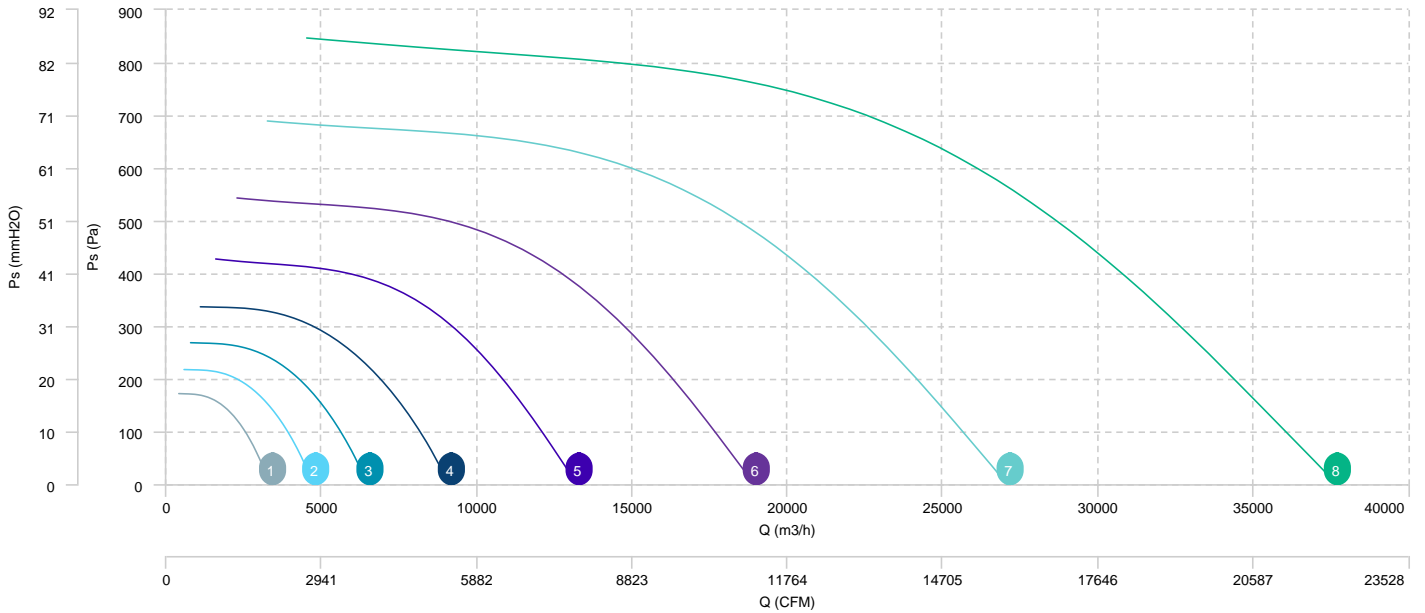

## AIR FLOW - ABSORBED POWER

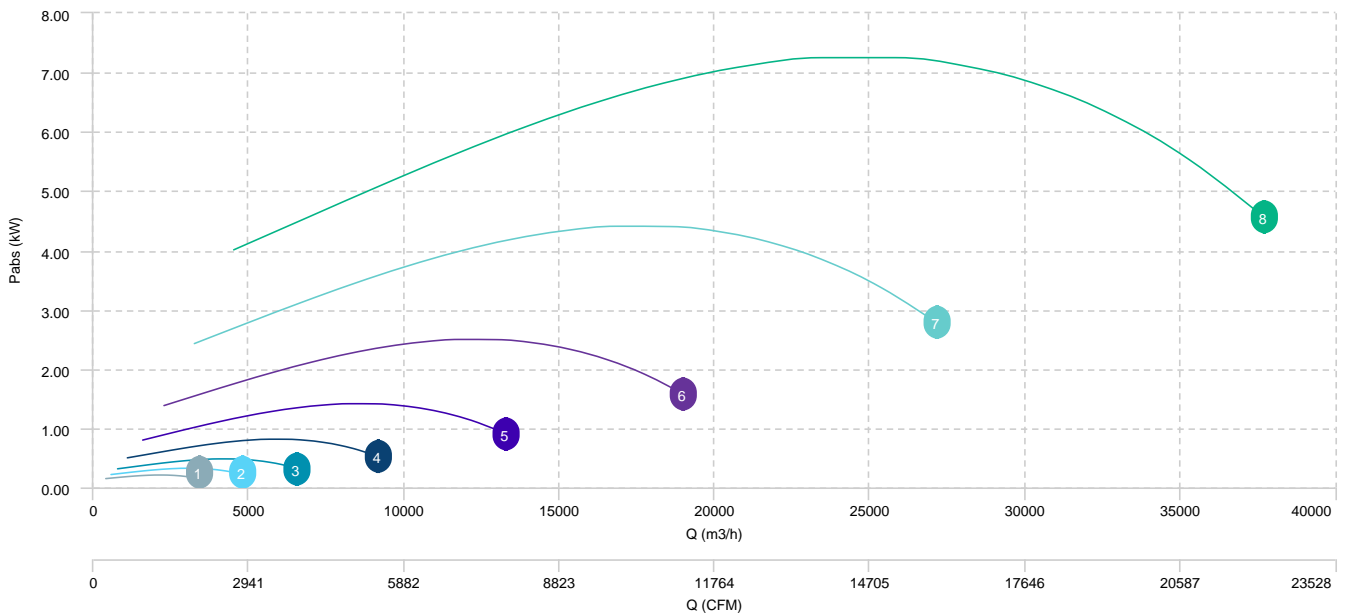

1 CTH3-A 1000 T8 7,5KW

AIR FLOW - PRESSURE

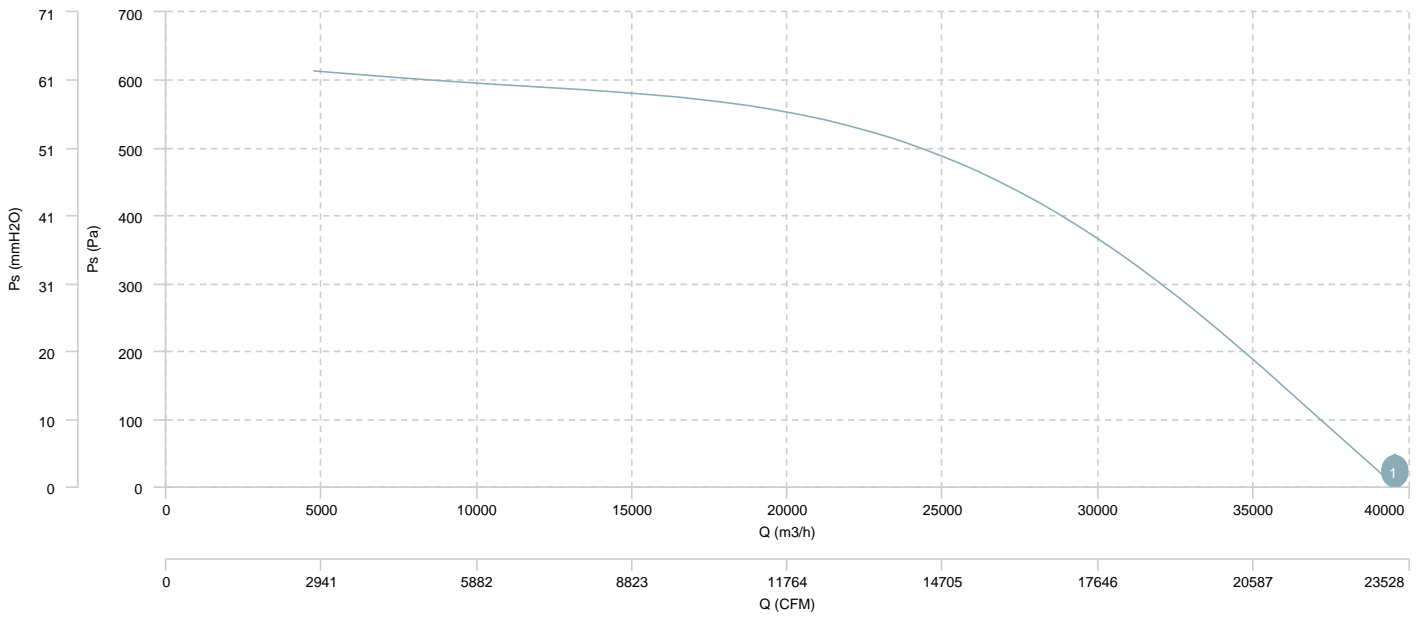

1	CTH3-A 315 T4/T8 0,25/0, 03KW	2	CTH3-A 355 T4/T8 0,55/0, 09KW	3	CTH3-A 400 T4/T8 0,75/0, 12KW	4	CTH3-A 450 T4/T8 1,1/0, 18KW
5	CTH3-A 500 T4/T8 1,5/0, 25KW	6	CTH3-A 560 T4/T8 3/0, 55KW				

## AIR FLOW - PRESSURE (4 poles)

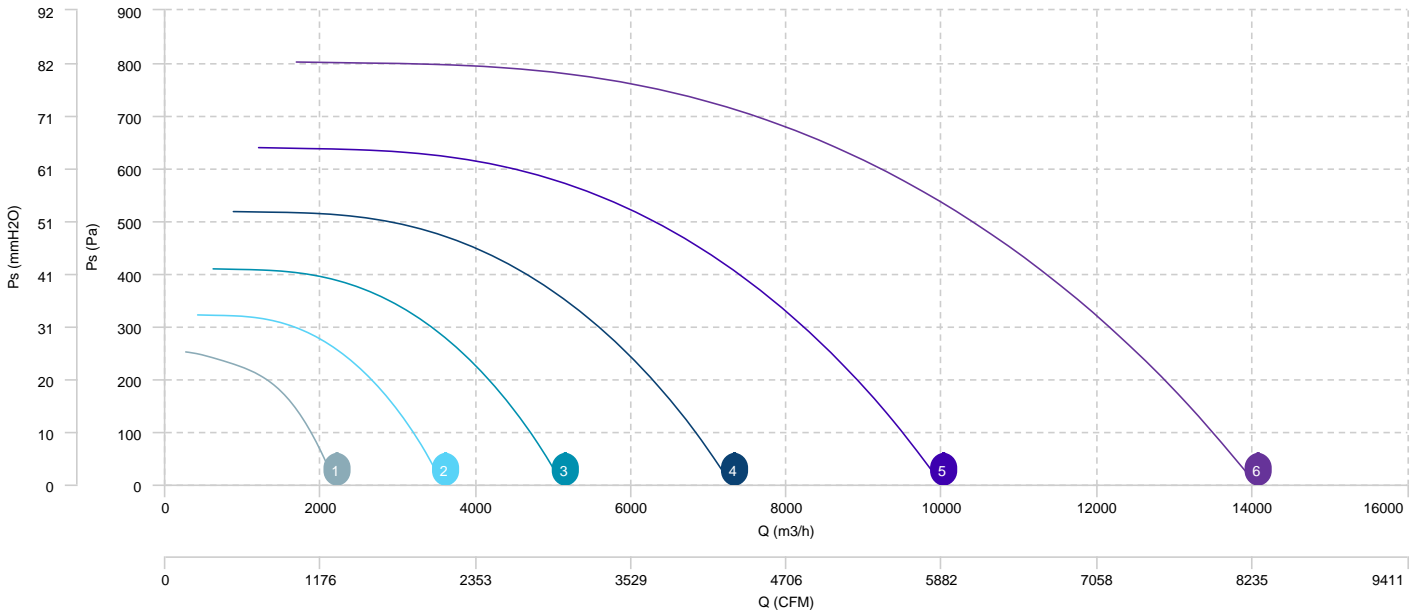

1	CTH3-A 315 T4/T8 0,25/0, 03KW	2	CTH3-A 355 T4/T8 0,55/0, 09KW	3	CTH3-A 400 T4/T8 0,75/0, 12KW	4	CTH3-A 450 T4/T8 1,1/0, 18KW
5	CTH3-A 500 T4/T8 1,5/0, 25KW	6	CTH3-A 560 T4/T8 3/0, 55KW				

## AIR FLOW - PRESSURE (8 poles)

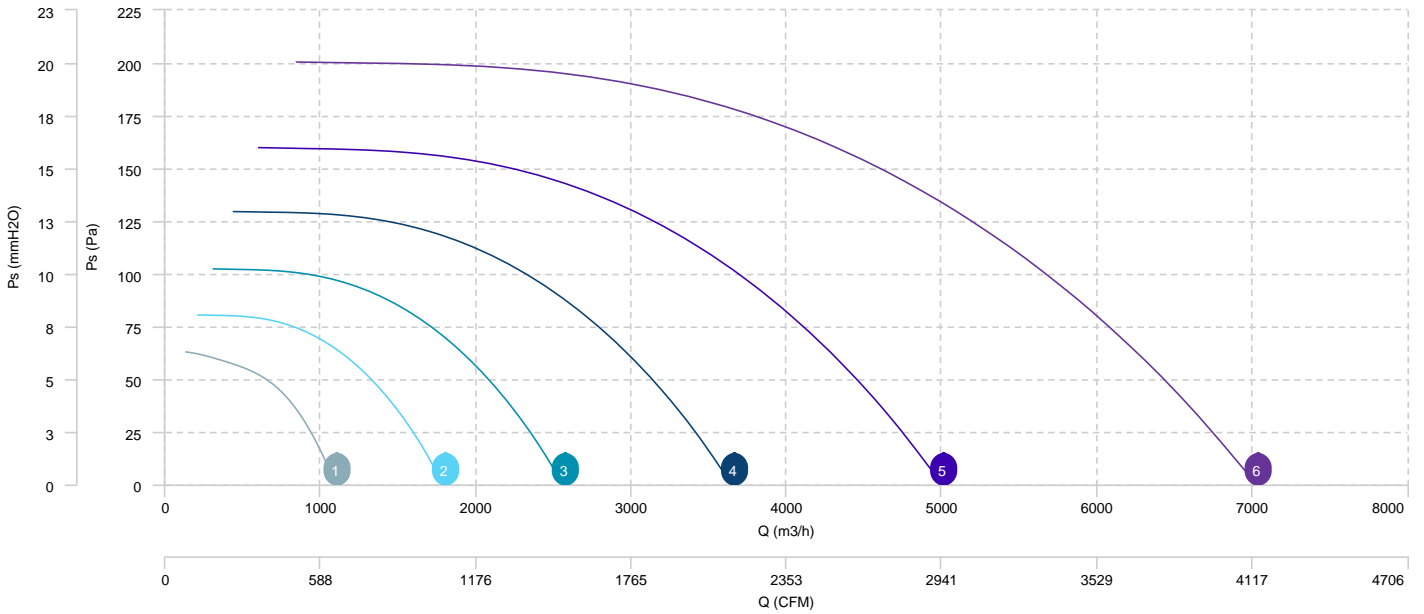



- |   |                                |   |                                |   |                               |   |                               |
|---|--------------------------------|---|--------------------------------|---|-------------------------------|---|-------------------------------|
| 1 | CTH3-A 500 T6/T12 0, 75/0,15KW | 2 | CTH3-A 560 T6/T12 0, 75/0,15KW | 3 | CTH3-A 630 T6/T12 1,5/0, 25KW | 4 | CTH3-A 710 T6/T12 2,2/0, 55KW |
| 5 | CTH3-A 800 T6/T12 4/1KW        |   |                                |   |                               |   |                               |

## AIR FLOW - PRESSURE (6 poles)

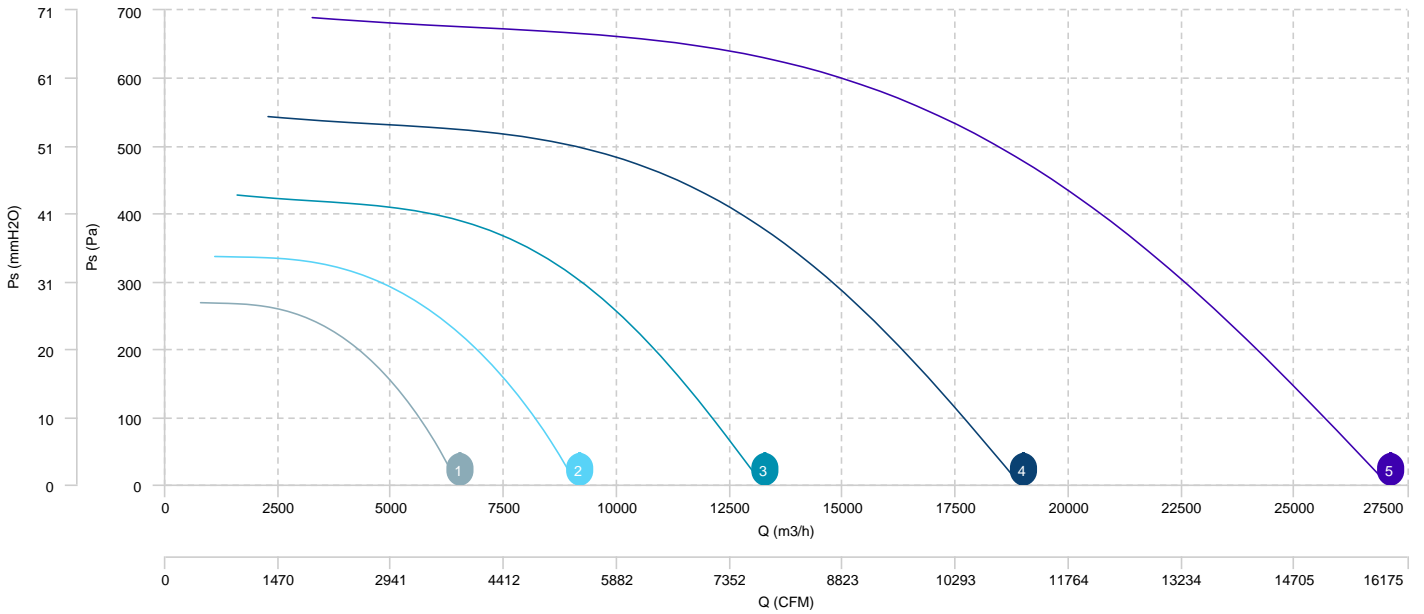

1	CTH3-A 500 T6/T12 0, 75/0,15KW	2	CTH3-A 560 T6/T12 0, 75/0,15KW	3	CTH3-A 630 T6/T12 1,5/0, 25KW	4	CTH3-A 710 T6/T12 2,2/0, 55KW
5	CTH3-A 800 T6/T12 4/1KW						

## AIR FLOW - PRESSURE (12 poles)

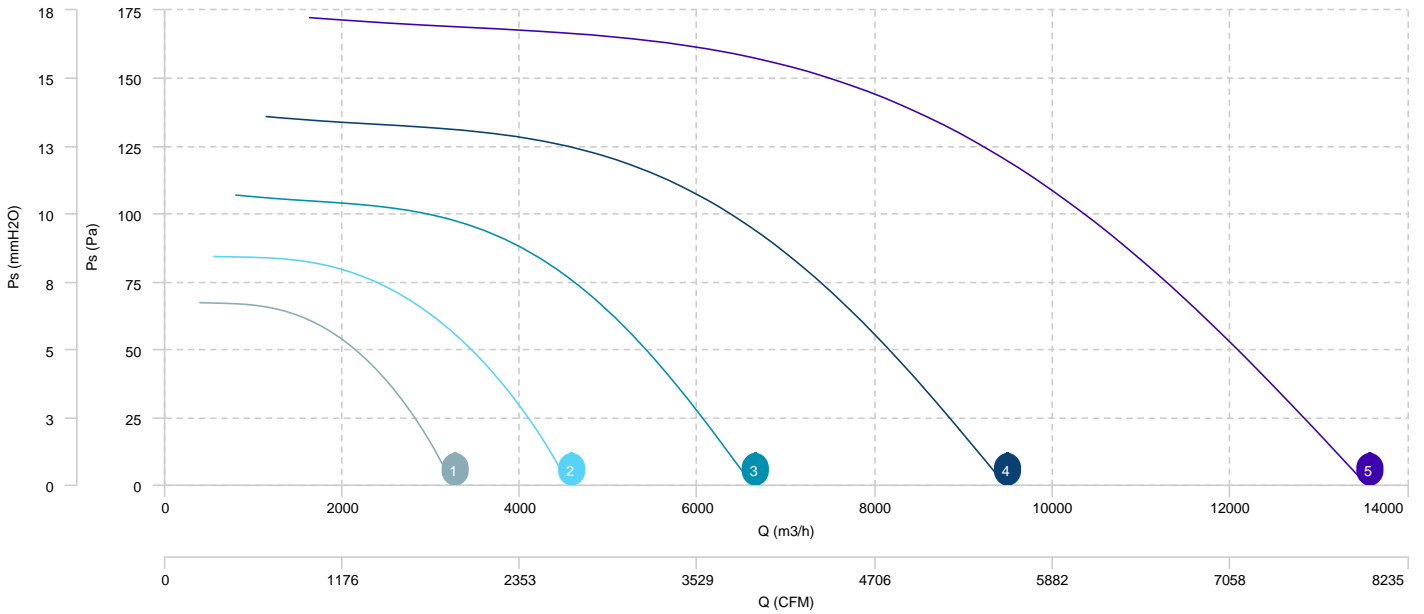

## Sound data

### Sound / 4 poles

Sound power Lw dB (A)										
Model		63 Hz	125 Hz	250 Hz	500 Hz	1000 Hz	2000 Hz	4000 Hz	8000 Hz	Total
CTH3-A 225 M4 0,12kW	Inlet	40	48	53	56	57	55	52	47	62
CTH3-A 225 T4 0,12kW	Inlet	40	48	53	56	57	55	52	47	62
CTH3-A 250 M4 0,12kW	Inlet	43	51	55	59	60	58	55	50	65
CTH3-A 250 T4 0,12kW	Inlet	43	51	55	59	60	58	55	50	65
CTH3-A 280 M4 0,12kW	Inlet	48	56	60	63	65	63	60	55	70
CTH3-A 280 T4 0,12kW	Inlet	48	56	60	63	65	63	60	55	70
CTH3-A 315 M4 0,25KW	Inlet	46	54	59	62	63	62	58	55	69
CTH3-A 315 T4 0,25KW	Inlet	46	54	59	62	63	62	58	55	69
CTH3-A 355 T4 0,55KW	Inlet	51	59	64	67	68	66	63	60	74
CTH3-A 400 T4 0,75KW	Inlet	54	62	67	70	71	69	66	63	77
CTH3-A 450 T4 1,1KW	Inlet	58	66	70	74	75	73	70	67	80
CTH3-A 500 T4 1,5KW	Inlet	61	69	74	77	78	76	73	70	83
CTH3-A 560 T4 3KW	Inlet	64	72	77	80	81	80	76	74	87

### Sound / 6 poles

Sound power Lw dB (A)										
Model		63 Hz	125 Hz	250 Hz	500 Hz	1000 Hz	2000 Hz	4000 Hz	8000 Hz	Total
CTH3-A 400 M6 0,37KW	Inlet	45	53	57	61	62	60	57	54	67
CTH3-A 400 T6 0,37KW	Inlet	45	53	57	61	62	60	57	54	67
CTH3-A 450 T6 0,37KW	Inlet	48	56	61	64	65	64	60	57	71
CTH3-A 500 T6 0,75KW	Inlet	52	60	64	67	69	67	64	61	74
CTH3-A 560 T6 0,75KW	Inlet	55	63	68	71	72	70	67	64	77
CTH3-A 630 T6 1,5KW	Inlet	59	67	71	74	76	74	71	68	81
CTH3-A 710 T6 2,2KW	Inlet	62	70	75	78	79	77	74	71	85
CTH3-A 800 T6 4KW	Inlet	66	74	78	82	83	81	78	75	88
CTH3-A 900 T6 11KW	Inlet	89	87	84	82	80	77	74	71	93

### Sound / 8 poles

Sound power Lw dB (A)										
Model		63 Hz	125 Hz	250 Hz	500 Hz	1000 Hz	2000 Hz	4000 Hz	8000 Hz	Total
CTH3-A 1000 T8 7,5KW	Inlet	87	85	82	80	78	75	72	69	91

## Sound / 4/8 poles

Sound power Lw dB (A)										
Model		63 Hz	125 Hz	250 Hz	500 Hz	1000 Hz	2000 Hz	4000 Hz	8000 Hz	Total
CTH3-A 315 T4/T8 0,25/0,03KW (710 RPM)	Inlet	30	38	42	46	47	45	42	39	52
CTH3-A 355 T4/T8 0,55/0,09KW (710 RPM)	Inlet	35	43	47	50	52	50	47	44	57
CTH3-A 400 T4/T8 0,75/0,12KW (710 RPM)	Inlet	38	46	50	53	55	53	50	47	60
CTH3-A 450 T4/T8 1,1/0,18KW (710 RPM)	Inlet	41	49	54	57	58	56	53	50	64
CTH3-A 500 T4/T8 1,5/0,25KW (710 RPM)	Inlet	44	52	57	60	61	60	56	54	67
CTH3-A 560 T4/T8 3/0,55KW (710 RPM)	Inlet	48	56	60	64	65	63	60	57	70

## Sound / 6/12 poles

Sound power Lw dB (A)										
Model		63 Hz	125 Hz	250 Hz	500 Hz	1000 Hz	2000 Hz	4000 Hz	8000 Hz	Total
CTH3-A 500 T6/T12 0,75/0,15KW (460 RPM)	Inlet	35	43	48	51	52	50	47	44	57
CTH3-A 560 T6/T12 0,75/0,15KW (460 RPM)	Inlet	38	46	51	54	55	54	50	48	61
CTH3-A 630 T6/T12 1,5/0,25KW (460 RPM)	Inlet	42	50	55	58	59	57	54	51	64
CTH3-A 710 T6/T12 2,2/0,55KW (460 RPM)	Inlet	46	54	58	62	63	61	58	55	68
CTH3-A 800 T6/T12 4/1KW (460 RPM)	Inlet	49	57	62	65	66	65	61	58	72

### Notes:

\* To calculate the sound power level at different rpm from those indicated above, use the following formula:

$$Lw \text{ dB(A)}_{rpmA} = Lw \text{ dB(A)}_{rpmB} + 52.5 \cdot \log_{10} \frac{rpmA}{rpmB}$$

## erp data

ERP	
Fan type	Unit for non-residential ventilation (LOT 6)
Typology	Unidirectional
Others	None
Type of driver	-

### ERP / 4 poles

Model	Motor power (kW)	Maximum efficiency point data						
		Eff.Heat recovery (%)	Max. efficiency (%)	Pabs (kW)	Air Flow (m3/h)	Ps (Pa)	Speed (m/s)	SFP (W/m3/s)
CTH3-A 315 T4 0,25KW	0,25	-	43,40	0,17	1.356,94	193,59	4.84	462,06
CTH3-A 355 T4 0,55KW	0,55	-	49,66	0,33	2.208,28	256,01	6.2	538,02
CTH3-A 400 T4 0,75KW	0,75	-	54,21	0,55	3.160,61	325,76	6.99	628,63
CTH3-A 450 T4 1,1KW	1,1	-	57,12	0,95	4.488,43	412,88	7.84	758,22
CTH3-A 500 T4 1,5KW	1,5	-	58,39	1,57	6.150,26	510,35	8.7	917,17
CTH3-A 560 T4 3KW	3	-	60,19	2,68	8.643,34	639,43	9.75	1.115,20

### ERP / 6 poles

Model	Motor power (kW)	Maximum efficiency point data						
		Eff.Heat recovery (%)	Max. efficiency (%)	Pabs (kW)	Air Flow (m3/h)	Ps (Pa)	Speed (m/s)	SFP (W/m3/s)
CTH3-A 400 T6 0,37KW	0,37	-	38,62	0,21	2.058,74	136,08	4.55	365,76
CTH3-A 450 T6 0,37KW	0,37	-	45,24	0,32	2.921,54	172,59	5.1	397,71
CTH3-A 500 T6 0,75KW	0,75	-	51,50	0,48	4.000,09	213,49	5.66	432,83
CTH3-A 560 T6 0,75KW	0,75	-	53,91	0,81	5.600,23	268,39	6.32	522,27
CTH3-A 630 T6 1,5KW	1,5	-	57,39	1,41	8.111,90	346,68	7.23	625,87
CTH3-A 710 T6 2,2KW	2,2	-	59,15	2,49	11.598,63	441,16	8.14	773,68
CTH3-A 800 T6 4KW	4	-	60,85	4,40	16.576,11	560,53	9.16	955,36
CTH3-A 900 T6 11KW	11	-	63,08	7,24	23.112,04	686,94	10.09	1.127,63