

MBP



MEDIUM PRESSURE WITH BACKWARD IMPELLER AND PLASTIC CONSTRUCTION

MANUFACTURING FEATURES:

- PE plastic housing.
- Backward impeller with self-cleaning system in PP plastic.
- Motor support made of rolled steel sheet with polyester powder finishing coat.
- Stainless steel nuts and bolts.
- Standard asynchronous squirrel-cage motor, IP-55, class F insulation.
- Standard voltages 230/400V 50Hz
- Standard orientation: LG270.

APPLICATIONS:

Designed for inline installation, they are suitable for:

- Corrosive air transport.
- Chemical and petrochemical industry.
- Laboratories and gas cabinets.
- Maximum temperature of transported air: If it is clean air 70°C, other depends on the gas (see table in documentation)

UNDER REQUEST:

- Single phase motors (up to 1,5Kw).
- 60Hz fans and special voltages fans.
- 2 speed motors.
- Stainless steel motor support.
- Casing made of PP.
- Orientation: RD0, RD45, RD90, RD135, RD180, RD225, RD270, RD315, LG0, LG45, LG90, LG135, LG180. LG225, LG315.

Accessories



AD AV AVR AVS

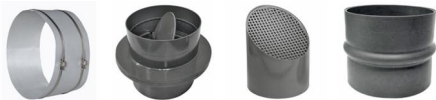

BA-400 CSC DG FJ

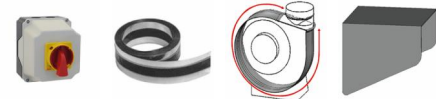

INT JE 45 PC PCM



PD RPI SFC WS

Technical data

Three-phase motor / 2 poles

Code	Model	R.P.M.	Rated I. A		Rated power kW	Max. Airflow m ³ /h	Sound db (A)**	Weight kg	Connect. diagram
			230V	400V					
502202013	MBP 20 T2 0,18kW	2710	1,00	0,55	0,18	1.110	57	9	1
502202515	MBP 25 T2 0,37kW	2730	1,7	0,97	0,37	2.110	65	13	1
502202817	MBP 28 T2 0,75kW	2840	3,00	1,75	0,75	3.140	69	19	1
502203119	MBP 31 T2 1,5kW	2850	5,5	3,2	1,50	4.360	71	26	1
502203527	MBP 35 T2 2,2kW	2860	7,9	4,54	2,20	6.630	73	32	1

Three-phase motor / 4 poles

Code	Model	R.P.M.	Rated I. A		Rated power kW	Max. Airflow m ³ /h	Sound db (A)**	Weight kg	Connect. diagram
			230V	400V					
502202039	MBP 20 T4 0,12kW	1360	1,00	0,55	0,12	580	42	9	1
502202539	MBP 25 T4 0,12kW	1360	1,00	0,55	0,12	1.100	49	10	1
502202840	MBP 28 T4 0,18kW	1310	1,2	0,7	0,18	1.570	53	14	1
502203141	MBP 31 T4 0,25kW	1350	1,4	0,8	0,25	2.170	55	19	1
502203542	MBP 35 T4 0,37kW	1370	1,9	1,1	0,37	3.310	57	23	1
502204043	MBP 40 T4 0,55kW	1370	2,7	1,58	0,55	4.510	62	33	1
502204545	MBP 45 T4 1,1kW	1420	4,3	2,5	1,10	6.060	63	40	1

Three-phase motor / 6 poles

Code	Model	R.P.M.	Rated I. A		Rated power kW	Max. Airflow m ³ /h	Sound db (A)**	Weight kg	Connect. diagram
			230V	400V					
502203168	MBP 31 T6 0,18kW	880	1,2	0,7	0,18	1.410	45	19	1
502203568	MBP 35 T6 0,18kW	880	1,2	0,7	0,18	2.140	47	23	1
502204069	MBP 40 T6 0,25kW	900	1,5	0,87	0,25	2.920	52	30	1
502204570	MBP 45 T6 0,37kW	900	2,1	1,23	0,37	3.930	52	37	1

Notes:

** Total sound pressure level at the point of maximum flow measured in dB(A) in the suction measured in free field at a distance of 6m from the source

Dimensions

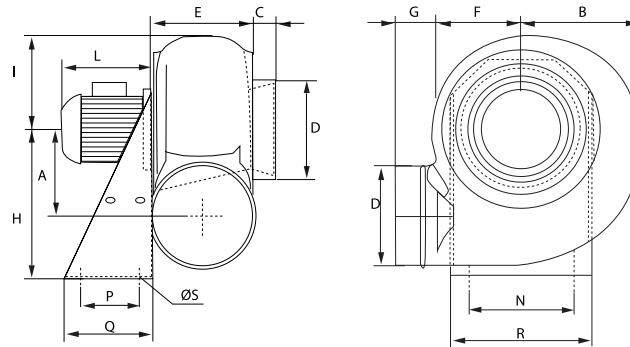

Model	A	B	C	DØ	E	F	G	H	I
MBP 20 T2 0,18kW	140	180	35	160	160	138	55	250	150
MBP 20 T4 0,12kW	140	180	35	160	160	138	55	250	150
MBP 25 T2 0,37kW	173	228	35	200	185	170	55	310	190
MBP 25 T4 0,12kW	173	228	35	200	185	170	55	310	190
MBP 28 T2 0,75kW	208	255	40	225	195	190	70	350	210
MBP 28 T4 0,18kW	208	255	40	225	195	190	70	350	210
MBP 31 T2 1,5kW	240	280	40	250	200	210	70	410	230
MBP 31 T4 0,25kW	240	280	40	250	200	210	70	410	230
MBP 31 T6 0,18kW	240	280	40	250	200	210	70	410	230
MBP 35 T2 2,2kW	260	312	40	280	237	230	50	445	270
MBP 35 T4 0,37kW	260	312	40	280	237	230	50	445	270
MBP 35 T6 0,18kW	260	312	40	280	237	230	50	445	270
MBP 40 T4 0,55kW	290	356	40	315	252	264	55	495	295
MBP 40 T6 0,25kW	290	356	40	315	252	264	55	495	295
MBP 45 T4 1,1kW	324	400	40	355	287	395	55	550	330
MBP 45 T6 0,37kW	324	400	40	355	287	295	55	550	330

Model	L	N	P	Q	R	S
MBP 20 T2 0,18kW	195	200	100	140	235	11
MBP 20 T4 0,12kW	190	200	100	140	235	11
MBP 25 T2 0,37kW	220	255	100	140	290	11
MBP 25 T4 0,12kW	190	255	100	140	290	11
MBP 28 T2 0,75kW	240	280	120	190	316	11
MBP 28 T4 0,18kW	190	280	120	190	316	11
MBP 31 T2 1,5kW	290	320	150	230	355	11

Model	L	N	P	Q	R	S
MBP 31 T4 0,25kW	220	320	150	230	355	11
MBP 31 T6 0,18kW	210	320	150	230	355	11
MBP 35 T2 2,2kW	290	355	150	230	390	11
MBP 35 T4 0,37kW	220	355	150	230	390	11
MBP 35 T6 0,18kW	210	355	150	230	390	11
MBP 40 T4 0,55kW	240	325	170	250	365	11
MBP 40 T6 0,25kW	220	325	170	250	365	11
MBP 45 T4 1,1kW	290	370	170	250	410	11
MBP 45 T6 0,37kW	240	370	170	250	410	11

Wiring diagram

DIAGRAM N° 1

230/400V

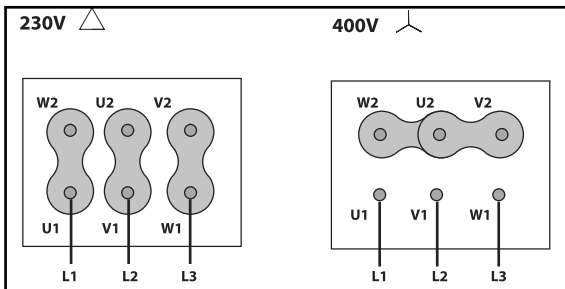

400/690V

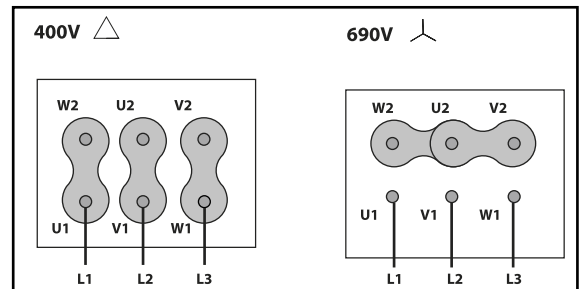

CHARACTERISTIC CURVE

- 1 MBP 20 T2 0,18kW
- 2 MBP 25 T2 0,37kW
- 3 MBP 28 T2 0,75kW
- 4 MBP 31 T2 1,5kW
- 5 MBP 35 T2 2,2kW

AIR FLOW - PRESSURE

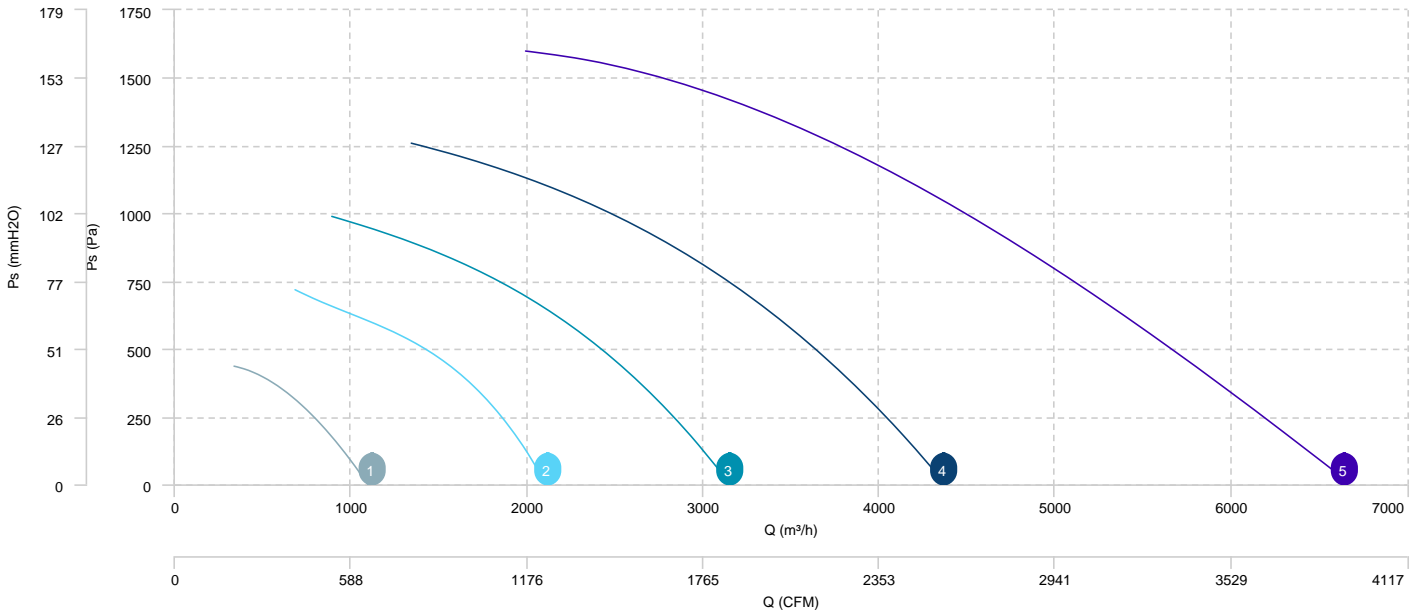

AIR FLOW - ABSORBED POWER

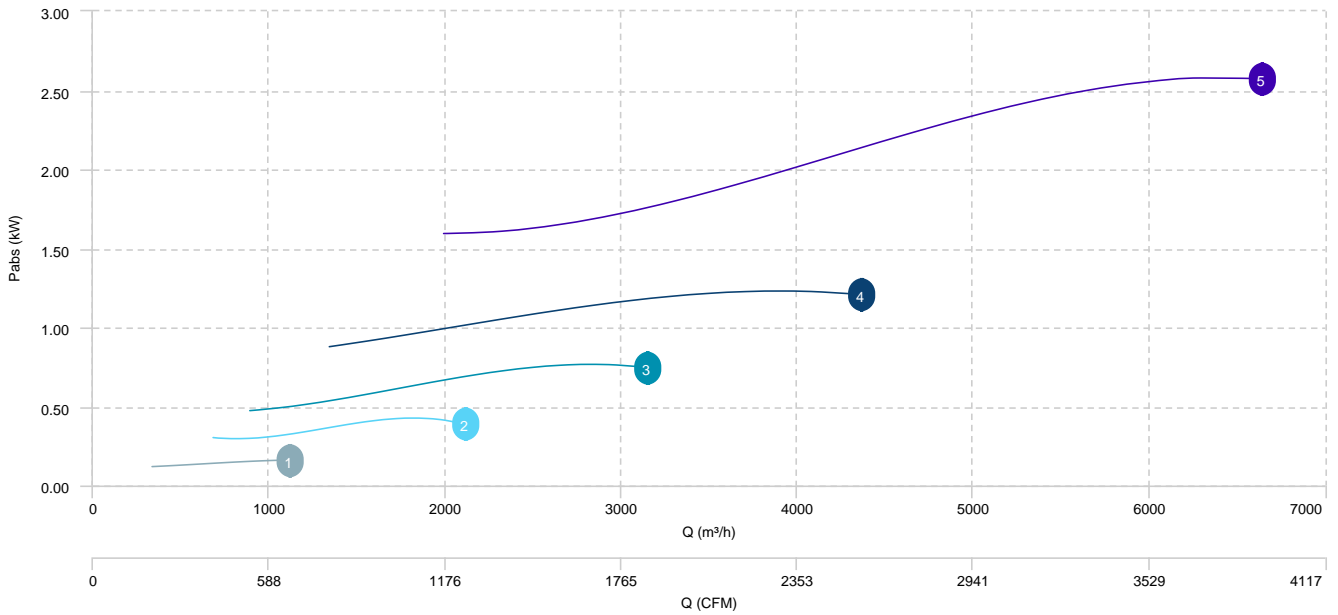

1	MBP 20 T4 0,12kW	2	MBP 25 T4 0,12kW	3	MBP 28 T4 0,18kW	4	MBP 31 T4 0,25kW
5	MBP 35 T4 0,37kW	6	MBP 40 T4 0,55kW	7	MBP 45 T4 1,1kW		

AIR FLOW - PRESSURE

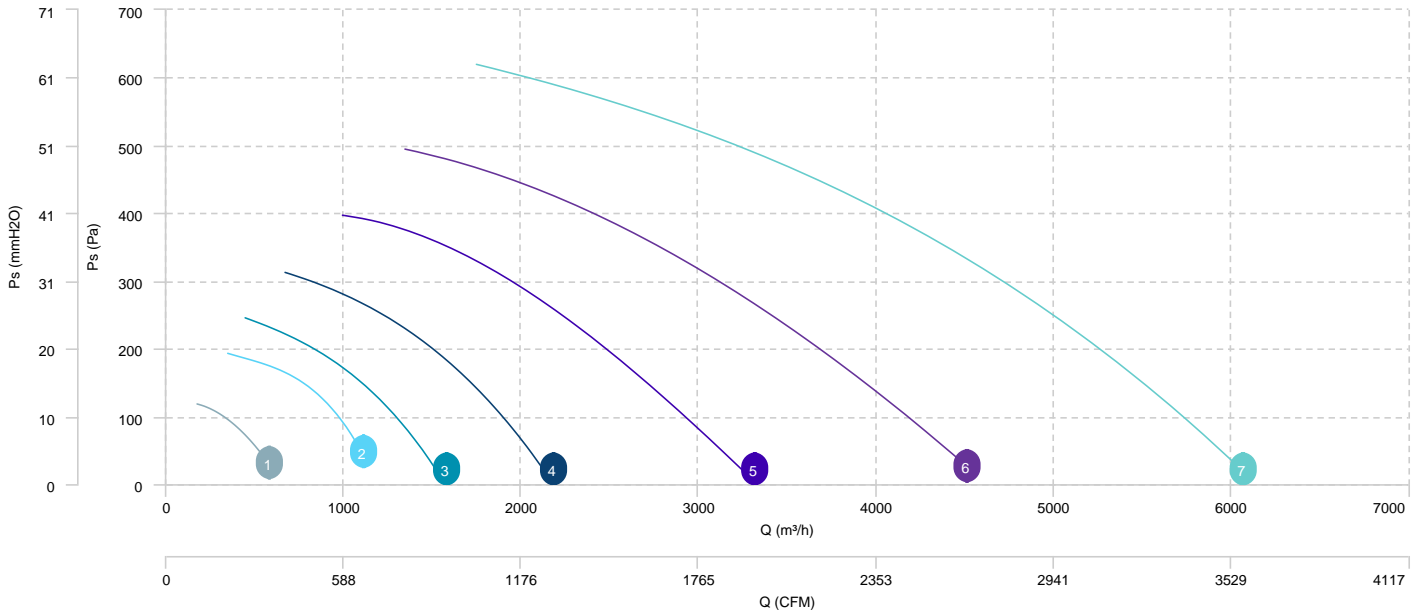

AIR FLOW - ABSORBED POWER

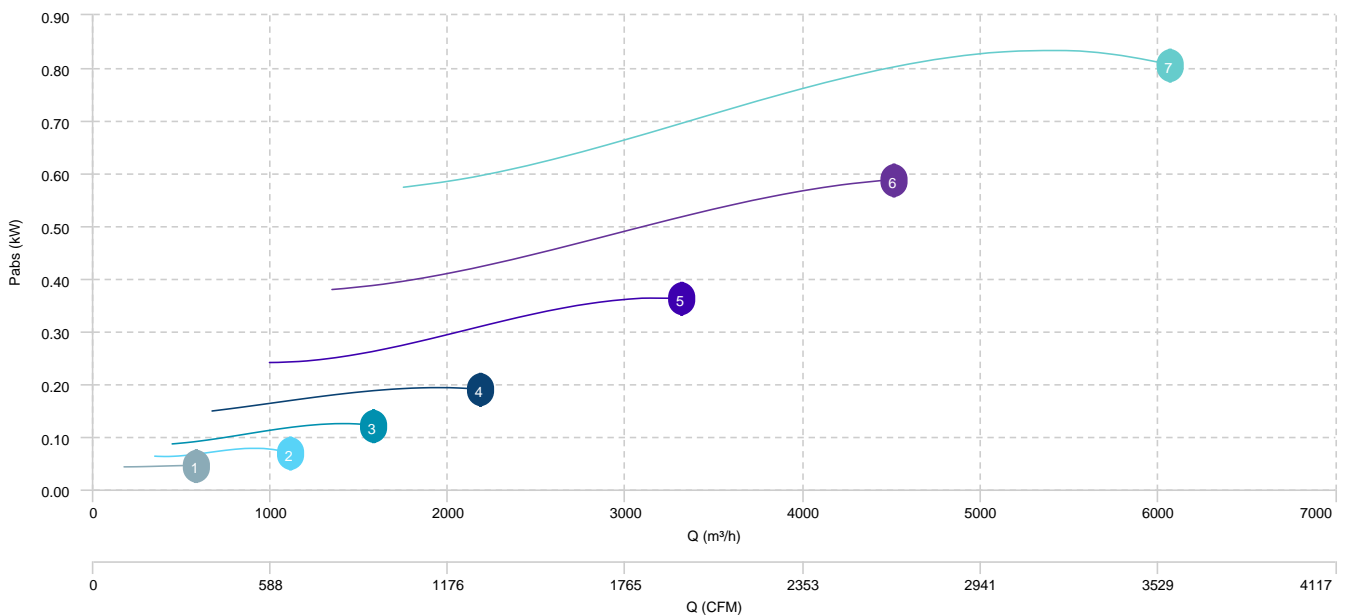

1 MBP 31 T6 0,18kW

2 MBP 35 T6 0,18kW

3 MBP 40 T6 0,25kW

4 MBP 45 T6 0,37kW

AIR FLOW - PRESSURE

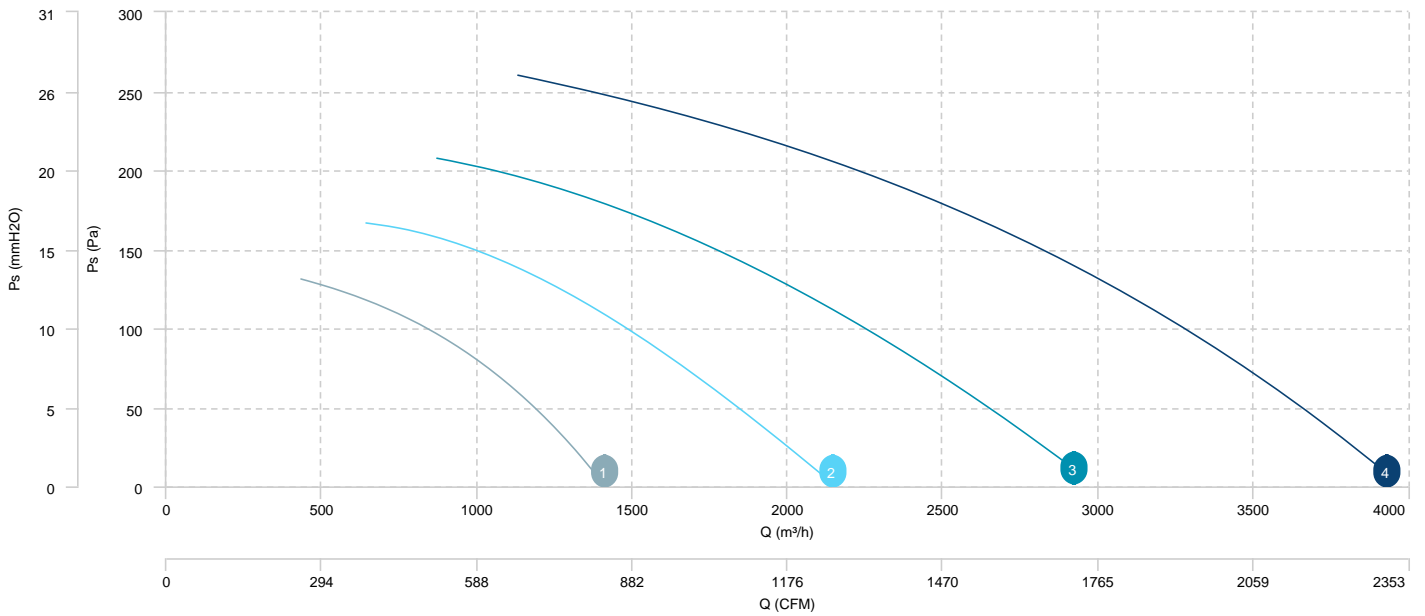

AIR FLOW - ABSORBED POWER

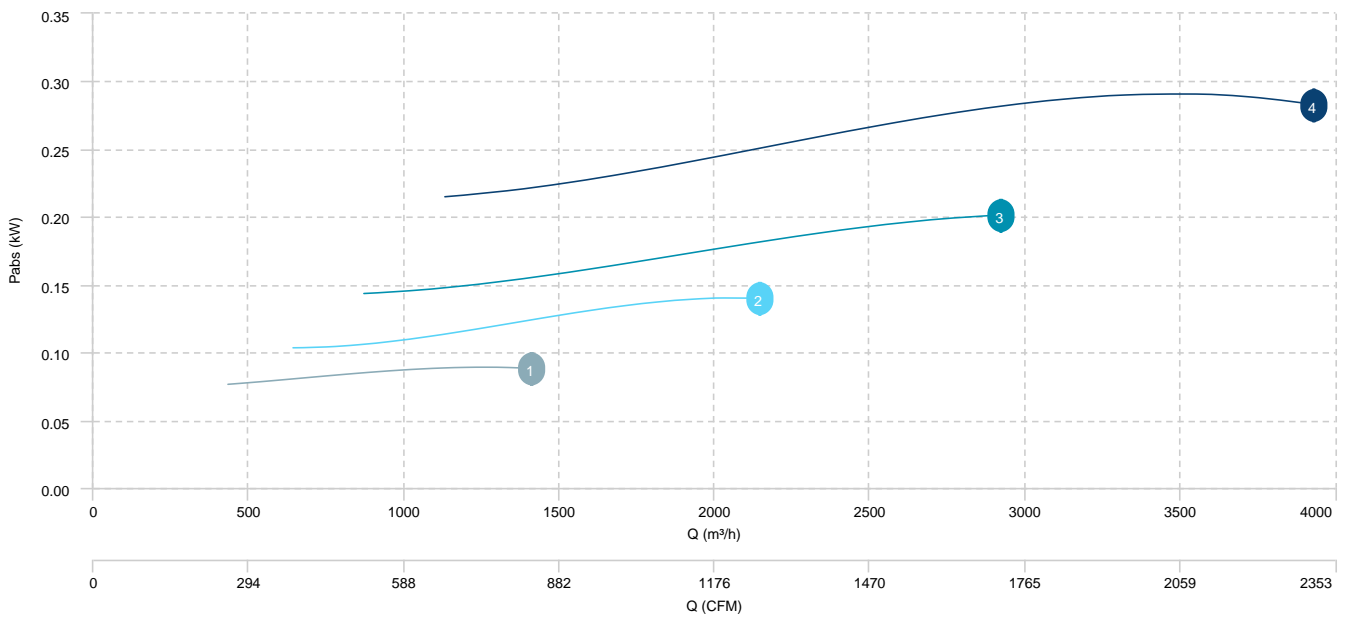

Sound data

Sound / 2 poles

Sound power Lw dB (A)										
Model		63 Hz	125 Hz	250 Hz	500 Hz	1000 Hz	2000 Hz	4000 Hz	8000 Hz	Total
MBP 20 T2 0,18kW	Inlet	76	78	79	74	73	68	60	52	83
MBP 25 T2 0,37kW	Inlet	83	85	86	81	80	75	67	59	91
MBP 28 T2 0,75kW	Inlet	87	89	87	88	84	79	71	63	95
MBP 31 T2 1,5kW	Inlet	90	92	90	91	87	82	74	66	97
MBP 35 T2 2,2kW	Inlet	91	93	94	89	88	83	75	67	99

Sound / 4 poles

Sound power Lw dB (A)										
Model		63 Hz	125 Hz	250 Hz	500 Hz	1000 Hz	2000 Hz	4000 Hz	8000 Hz	Total
MBP 20 T4 0,12kW	Inlet	61	63	64	59	58	53	45	37	68
MBP 25 T4 0,12kW	Inlet	68	70	71	66	65	60	52	44	75
MBP 28 T4 0,18kW	Inlet	71	73	71	72	68	63	55	47	79
MBP 31 T4 0,25kW	Inlet	74	76	74	75	71	66	58	50	81
MBP 35 T4 0,37kW	Inlet	76	78	79	74	73	68	60	52	83
MBP 40 T4 0,55kW	Inlet	81	83	84	79	78	73	65	57	88
MBP 45 T4 1,1kW	Inlet	81	83	84	79	78	73	65	57	89

Sound / 6 poles

Sound power Lw dB (A)										
Model		63 Hz	125 Hz	250 Hz	500 Hz	1000 Hz	2000 Hz	4000 Hz	8000 Hz	Total
MBP 31 T6 0,18kW	Inlet	63	65	63	64	60	55	47	39	71
MBP 35 T6 0,18kW	Inlet	65	67	68	63	62	57	49	41	73
MBP 40 T6 0,25kW	Inlet	70	72	73	68	67	62	54	46	78
MBP 45 T6 0,37kW	Inlet	70	72	73	68	67	62	54	46	78